



2.4mm Female Connector Clamp/Solder (Captive Contact) Attachment End Launch PCB, Removable End Launch, Standard Profile

RF Connectors Technical Data Sheet

PE45511

Configuration

- 2.4mm Female Connector
- 50 Ohms
- Straight Body Geometry
- End Launch Interface Type
- Clamp/Solder (Captive Contact) Attachment

Features

- Max. Operating Frequency 50 GHz
- Good VSWR of 1.4:1
- Gold Plated Beryllium Copper Contact
- Reusable end launch installation
- PCB Solder or Solderless Contact
- M1.6-0.35 Mounting Screws

Applications

- General Purpose Test
- PCB Applications
- Coplanar Waveguide Edge Launches
- Signal Integrity Measurements
- Chip Evaluations
- SERDES
- 25 GbE
- Substrate Characterization
- Test Fixtures

Description

Pasternack's PE45511 2.4mm removable end launch PCB connector is part of our full line of RF components available for same-day shipping. Our 2.4mm solderless edge launch connector operates to a maximum frequency of 50 GHz and offers a low VSWR of 1.4:1. The clamp-on removable design allows this connector to be reused, supporting multiple chip evaluations, signal integrity and millimeter wave applications.

Our 2.4mm solderless end launch PCB connector PE45511 datasheet specifications and drawing with dimensions are shown below in this PDF. Pasternack's broad catalog of RF, microwave and millimeter wave connectors allows designers to configure and customize their signal connections however they like. Whether the need is to provide superior signal integrity, higher data rates or simply a test fixture, Pasternack has the right high speed PCB edge launch connections for you.

Electrical Specifications

Description	Minimum	Typical	Maximum	Units
Frequency Range	DC		50	GHz
VSWR			1.4:1	
Insertion Loss			0.43	dB
Operating Voltage (AC)			400	Vrms

Electrical Specification Notes:

Actual VSWR performance is largely dependent on circuit board design. For optimal results, the connector and circuit launch geometry should be modeled using Electromagnetic Simulation tools.

Click the following link (or enter part number in "SEARCH" on website) to obtain additional part information including price, inventory and certifications: [2.4mm Female Connector Clamp/Solder \(Captive Contact\) Attachment End Launch PCB, Removable End Launch, Standard Profile PE45511](#)



2.4mm Female Connector Clamp/Solder
(Captive Contact) Attachment End Launch PCB,
Removable End Launch, Standard Profile

RF Connectors
Technical Data Sheet

PE45511

Mechanical Specifications

Size

Length	0.789 in [20.04 mm]
Width/Dia.	0.5 in [12.70 mm]
Height	0.5 in [12.7 mm]

Material Specifications

Description	Material	Plating
Contact	Beryllium Copper	Gold
Insulation	PEI	
Outer Conductor	Passivated Stainless Steel	
Body	Passivated Stainless Steel	

Mechanical Specification Notes:
Launch Pin is Gold Plated Beryllium Copper

Environmental Specifications

Temperature

Operating Range	-40 to +125 deg C
-----------------	-------------------

Compliance Certifications (see [product page](#) for current document)

Plotted and Other Data

Notes:

Click the following link (or enter part number in "SEARCH" on website) to obtain additional part information including price, inventory and certifications: [2.4mm Female Connector Clamp/Solder \(Captive Contact\) Attachment End Launch PCB, Removable End Launch, Standard Profile PE45511](#)



2.4mm Female Connector Clamp/Solder
(Captive Contact) Attachment End Launch PCB,
Removable End Launch, Standard Profile

RF Connectors
Technical Data Sheet

PE45511

Assembly Instruction

Step 1: Mount the end launch connector in the desired position on the board.

Step 2: Center the connector on the trace.

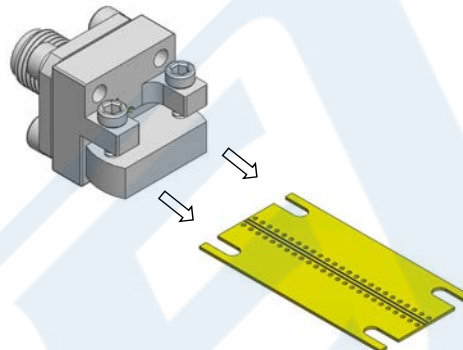

Step 3: Verify that the transition block is secured on the board.

Step 4: Tighten the M1.6-0.35 mounting screws to the boards suggested torque or until the connectors is secure.

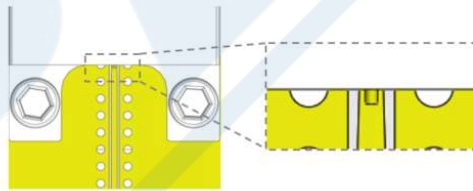

(Steps 5-7 optional, depending on application)

Step 5: If soldering the launch pin to the trace, flow solder the entire length of the contact area.

Step 6: To avoid performance mistakes, remove excess solder.

Step 7: Clean any residue from around the solder joint.

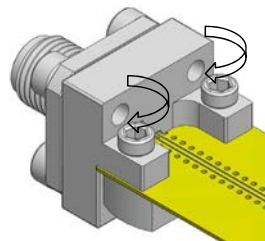

Click the following link (or enter part number in "SEARCH" on website) to obtain additional part information including price, inventory and certifications: [2.4mm Female Connector Clamp/Solder \(Captive Contact\) Attachment End Launch PCB, Removable End Launch, Standard Profile PE45511](#)



2.4mm Female Connector Clamp/Solder
(Captive Contact) Attachment End Launch PCB,
Removable End Launch, Standard Profile

RF Connectors
Technical Data Sheet

PE45511

Recommended PCB Cutouts

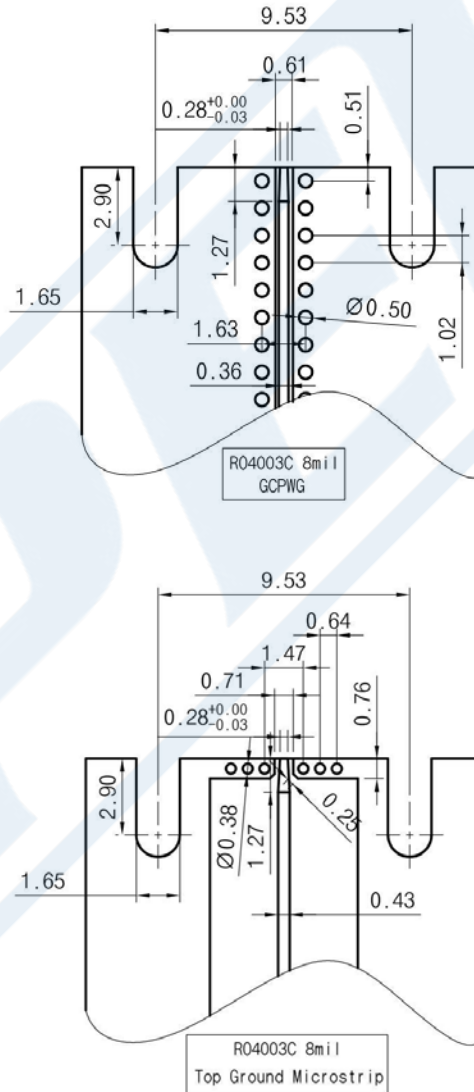

Click the following link (or enter part number in "SEARCH" on website) to obtain additional part information including price, inventory and certifications: [2.4mm Female Connector Clamp/Solder \(Captive Contact\) Attachment End Launch PCB, Removable End Launch, Standard Profile PE45511](#)



2.4mm Female Connector Clamp/Solder
(Captive Contact) Attachment End Launch PCB,
Removable End Launch, Standard Profile

RF Connectors
Technical Data Sheet

PE45511

Typical Performance Data

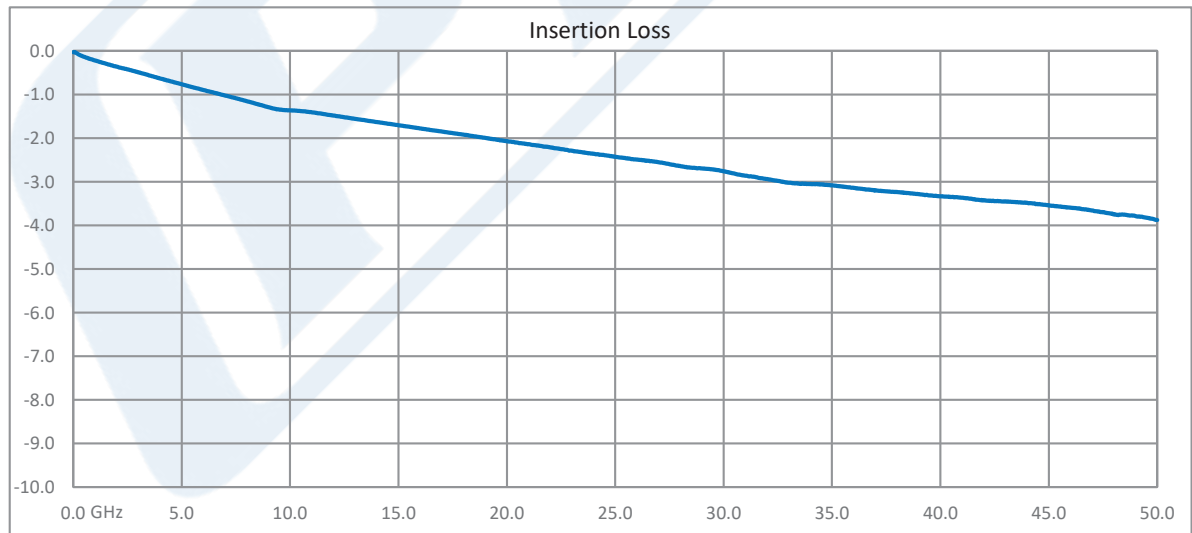
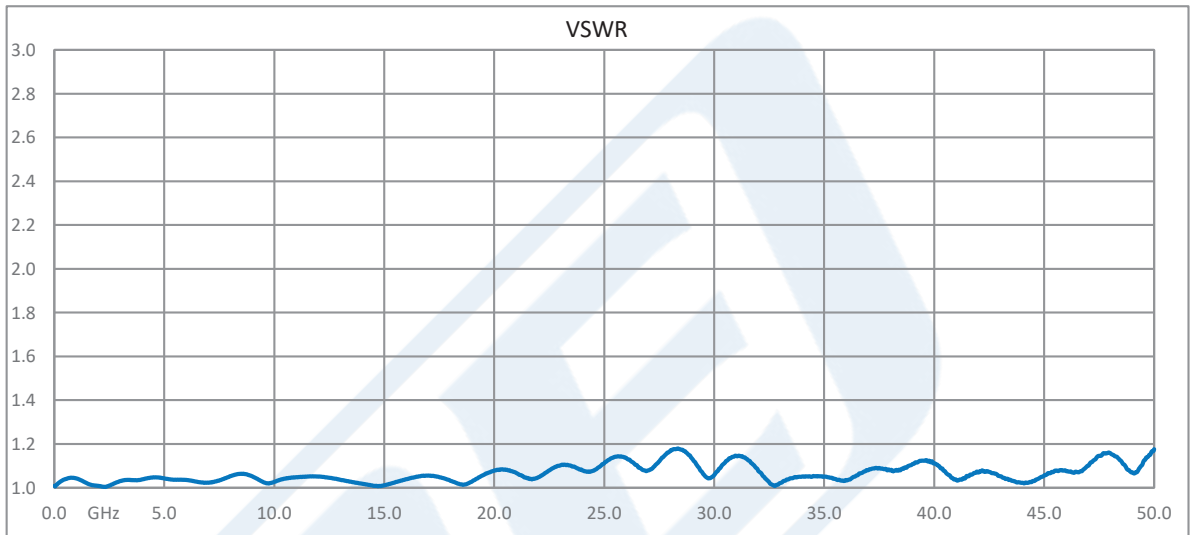

Measurement is for two connectors with 1.0 inch (25.4mm) length of substrate

Click the following link (or enter part number in "SEARCH" on website) to obtain additional part information including price, inventory and certifications: [2.4mm Female Connector Clamp/Solder \(Captive Contact\) Attachment End Launch PCB, Removable End Launch, Standard Profile PE45511](#)



2.4mm Female Connector Clamp/Solder
(Captive Contact) Attachment End Launch PCB,
Removable End Launch, Standard Profile

RF Connectors
Technical Data Sheet

PE45511

2.4mm Female Connector Clamp/Solder (Captive Contact) Attachment End Launch PCB, Removable End Launch, Standard Profile from Pasternack Enterprises has same day shipment for domestic and International orders. Our RF, microwave and millimeter wave products maintain a 99.4% availability and are part of the broadest selection in the industry.

Click the following link (or enter part number in "SEARCH" on website) to obtain additional part information including price, inventory and certifications: [2.4mm Female Connector Clamp/Solder \(Captive Contact\) Attachment End Launch PCB, Removable End Launch, Standard Profile PE45511](https://www.pasternack.com/2.4mm-female-end-launch-pcb-connector-pe45511-p.aspx)

URL: <https://www.pasternack.com/2.4mm-female-end-launch-pcb-connector-pe45511-p.aspx>

The information contained in this document is accurate to the best of our knowledge and representative of the part described herein. It may be necessary to make modifications to the part and/or the documentation of the part, in order to implement improvements. Pasternack reserves the right to make such changes as required. Unless otherwise stated, all specifications are nominal. Pasternack does not make any representation or warranty regarding the suitability of the part described herein for any particular purpose, and Pasternack does not assume any liability arising out of the use of any part or documentation.

PE45511 CAD Drawing

2.4mm Female Connector Clamp/Solder (Captive Contact) Attachment
End Launch PCB, Removable End Launch, Standard Profile

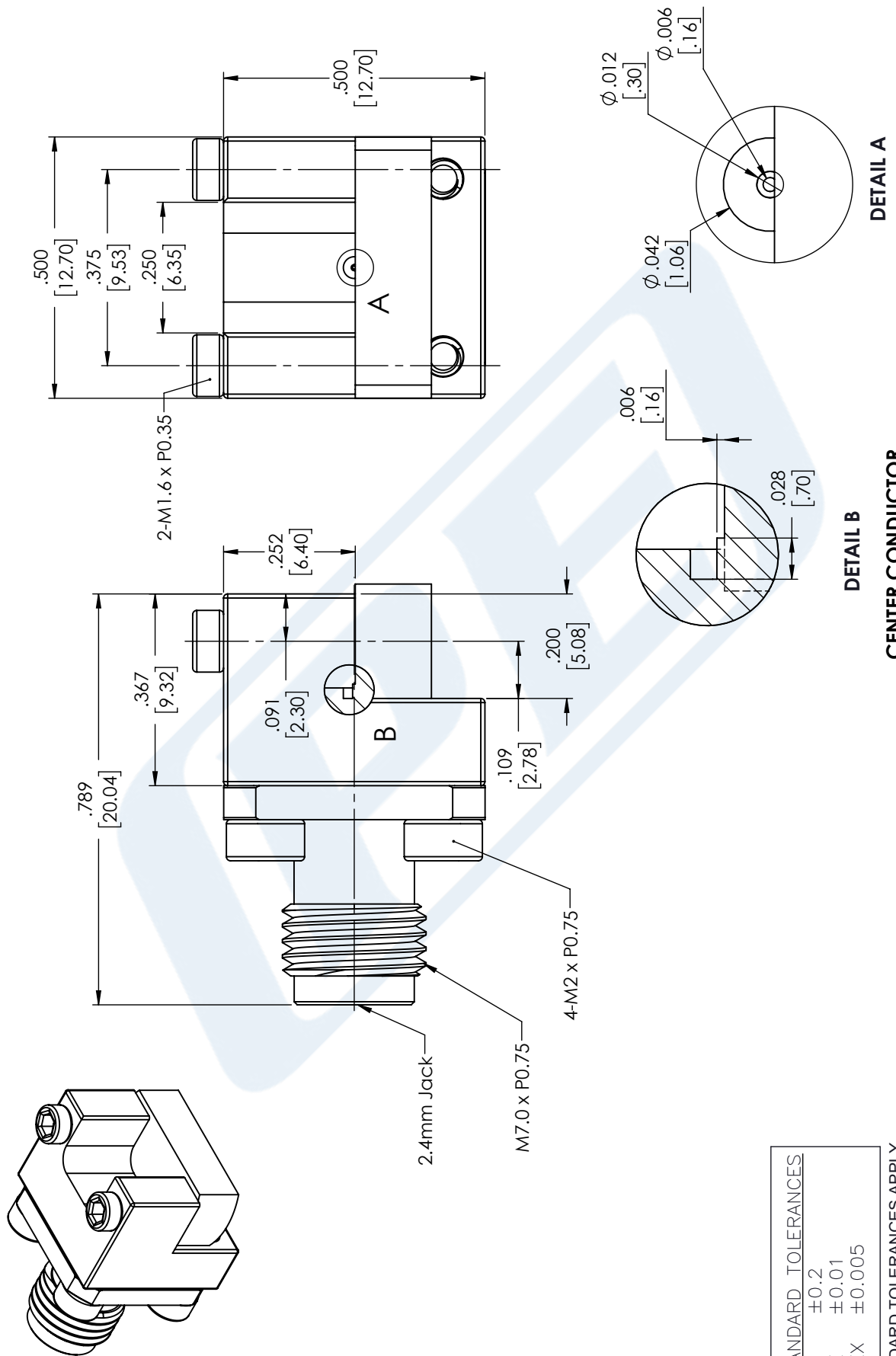

STANDARD TOLERANCES
.X ±0.2
.XX ±0.01
.XXX ±0.005

*STANDARD TOLERANCES APPLY ONLY TO DIMENSIONS IN INCHES

PE PASTERNAK®
THE ENGINEER'S RF SOURCE
Pasternack Enterprises, Inc.
P.O. Box 16759 | Irvine | CA | 92623
Phone: (949) 261-1920 | Fax: (949) 261-7451
Website: www.pasternack.com | E-Mail: sales@pasternack.com

DWG TITLE	PE45511
CAGE CODE	53919

NOTES: 1. UNLESS OTHERWISE SPECIFIED ALL DIMENSIONS ARE NOMINAL. 2. ALL SPECIFICATIONS ARE SUBJECT TO CHANGE WITHOUT NOTICE AT ANY TIME 3. DIMENSIONS ARE IN INCHES [mm].			
CAD FILE	MDDYY	SCALE	N/A
SIZE	A		
CN2245			