



2x Frequency Multiplier Module, 32 GHz to 46 GHz Output Frequency, +8 dBm Output Power, Field Replaceable 2.92mm

Frequency Multipliers Technical Data Sheet

PE88X2002

Features

- X2 Frequency Multiplier
- Wide Frequency Band
- GaAs HBT MMIC Technology
- Low Phase Noise -130 dBc/Hz @ 100 kHz offset
- Output Power +13 dBm
- Single +5V Bias Voltage
- Integrated DC Blocking Capacitors
- Hermetically Sealed Module
- Mil Spec Compliant
- Field Replaceable 2.92mm Connectors
- -55°C to +85°C Operating Temperature

Applications

- Electronic Warfare
- Electronic Countermeasures
- Point-To-Point Radio
- Point-To-Multipoint Radio
- VSAT Radios
- Fiber Optic
- Space Systems
- Test Instrumentation
- Telecom Infrastructure

Description

The PE88X2002 is a low noise X2 Active Broadband Frequency Multiplier Module that covers a wide output frequency bandwidth from 32 GHz to 46 GHz. The design utilizes advanced GaAs HBT MMIC semiconductor technology that produces low additive SSB phase noise performance with a typical level of -130 dBc/Hz at 100 kHz offset. Additional typical performance includes an output power level of +13 dBm with an input signal of +3 dBm. Input/output ports are matched for 50 ohms and are DC blocked. The design requires a single +5V DC supply. The compact drop-in package is RoHS compliant and hermetically sealed with field replaceable 2.92mm connectors. And for added confidence, this rugged package assembly is designed to meet MIL-STD-883 test conditions for Hermeticity and Temperature Cycle.

Electrical Specifications (TA= 25°C)

Description	Minimum	Typical	Maximum	Units
Input Frequency Range	16		23	GHz
Output Frequency Range	32		46	GHz
Impedance		50		Ohms
Output Power	+8	+13		dBm
Spurious Suppression				dBc

Click the following link (or enter part number in "SEARCH" on website) to obtain additional part information including price, inventory and certifications: [2x Frequency Multiplier Module, 32 GHz to 46 GHz Output Frequency, +8 dBm Output Power, Field Replaceable 2.92mm PE88X2002](#)



2x Frequency Multiplier Module, 32 GHz to 46 GHz Output Frequency, +8 dBm Output Power, Field Replaceable 2.92mm

Frequency Multipliers Technical Data Sheet

PE88X2002

Performance by Frequency

Description	Min.	Typ.	Max.	Units
Frequency Range, Input		16 - 23		GHz
Frequency Range, Output		32 - 46		GHz
Output Power	+8	+13		dBm
Fo Isolation (With Respect To Output Level)		30		dBc
Input Return Loss		12		dB
Output Return Loss		8		dB
SSB Phase Noise (100 KHz Offset)		-130		dBc/Hz
Supply Current		70		mA

Mechanical Specifications

Size

Length	1.086 in [27.58 mm]
Width	0.85 in [21.59 mm]
Height	0.28 in [7.11 mm]
Weight	0.088 lbs [39.92 g]
Input Connector	Field Replaceable 2.92mm Female
Output Connector	Field Replaceable 2.92mm Female

Environmental Specifications

Temperature

Operating Range	-55 to +85 deg C
Storage Range	-65 to +150 deg C

ESD Sensitivity

ESD Sensitive Material, Transport material in Approved ESD bags. Handle only in ESD Workstation.



Compliance Certifications (visit www.Pasternack.com for current document)

RoHS Compliant

Plotted and Other Data

Notes:

Click the following link (or enter part number in "SEARCH" on website) to obtain additional part information including price, inventory and certifications: [2x Frequency Multiplier Module, 32 GHz to 46 GHz Output Frequency, +8 dBm Output Power, Field Replaceable 2.92mm PE88X2002](#)

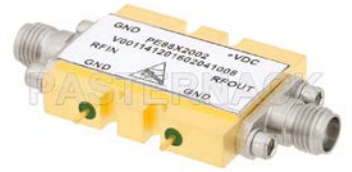

2x Frequency Multiplier Module, 32 GHz to 46 GHz Output Frequency, +8 dBm Output Power, Field Replaceable 2.92mm

Frequency Multipliers Technical Data Sheet

PE88X2002

Functional Block Diagram

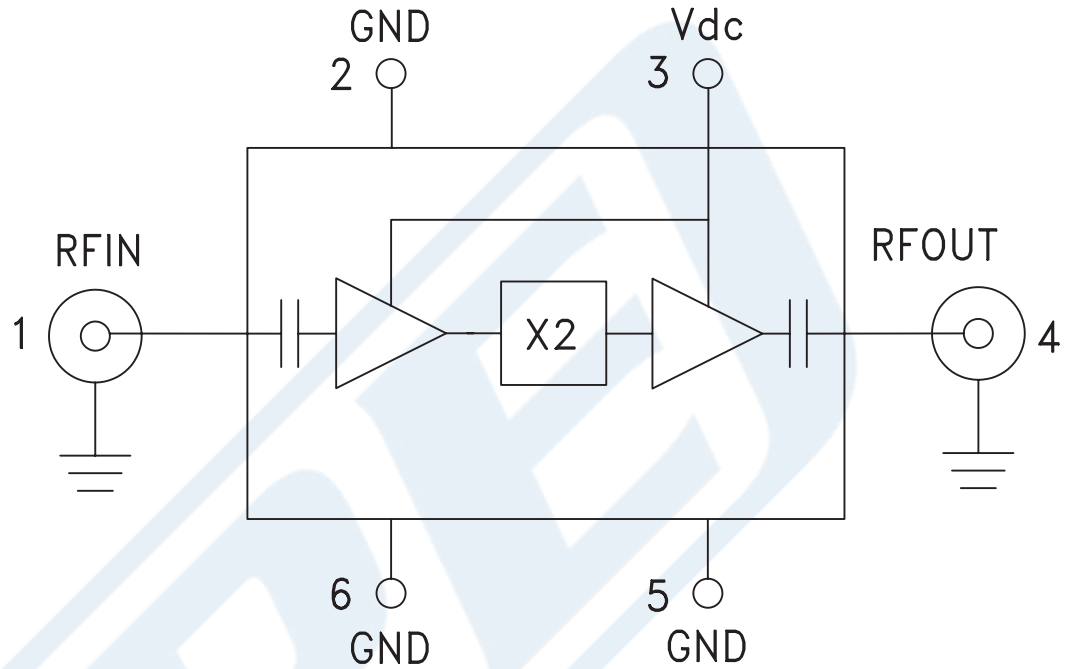

Click the following link (or enter part number in "SEARCH" on website) to obtain additional part information including price, inventory and certifications: [2x Frequency Multiplier Module, 32 GHz to 46 GHz Output Frequency, +8 dBm Output Power, Field Replaceable 2.92mm PE88X2002](#)



2x Frequency Multiplier Module, 32 GHz to 46 GHz Output Frequency, +8 dBm Output Power, Field Replaceable 2.92mm

Frequency Multipliers Technical Data Sheet

PE88X2002

Typical Performance Data

Output Power vs. Temperature @ 3 dBm Drive Level

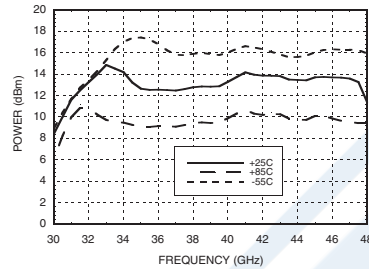

Output Power vs. Drive Level

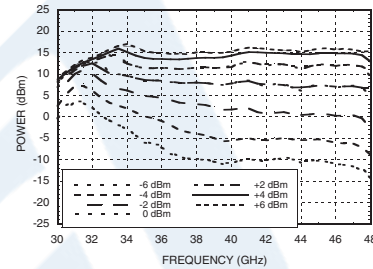

Output Power vs. Supply Voltage @ 3 dBm Drive Level

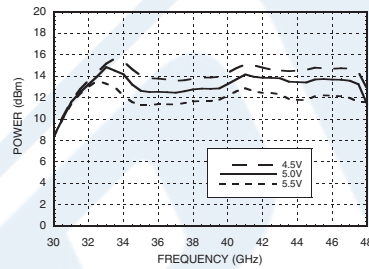

Isolation @ 3 dBm Drive Level

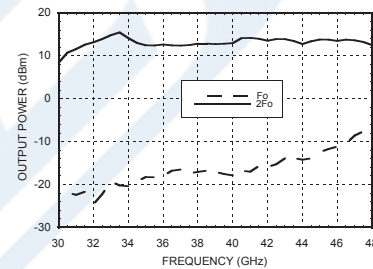

Output Power vs. Input Power

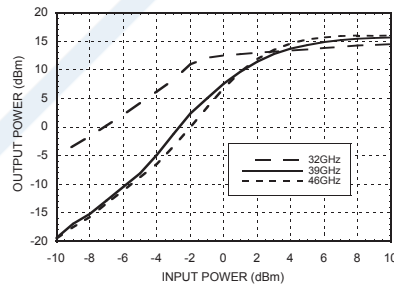

Click the following link (or enter part number in "SEARCH" on website) to obtain additional part information including price, inventory and certifications: [2x Frequency Multiplier Module, 32 GHz to 46 GHz Output Frequency, +8 dBm Output Power, Field Replaceable 2.92mm PE88X2002](#)



2x Frequency Multiplier Module, 32 GHz to 46 GHz Output Frequency, +8 dBm Output Power, Field Replaceable 2.92mm

Frequency Multipliers Technical Data Sheet

PE88X2002

Input Return Loss vs. Temperature @ 0 dBm Drive Level

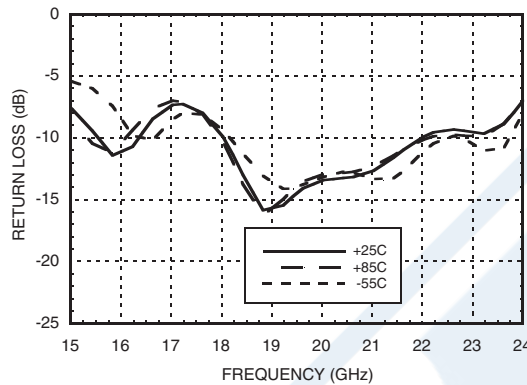

Output Return Loss vs. Temperature @ 0 dBm Drive Level

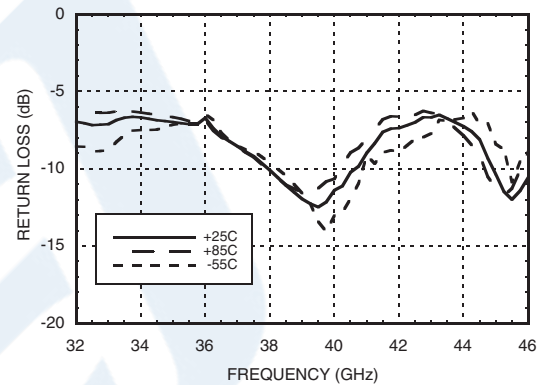

2x Frequency Multiplier Module, 32 GHz to 46 GHz Output Frequency, +8 dBm Output Power, Field Replaceable 2.92mm from Pasternack Enterprises has same day shipment for domestic and International orders. Our RF, microwave and millimeter wave products maintain a 99% availability and are part of the broadest selection in the industry.

Click the following link (or enter part number in "SEARCH" on website) to obtain additional part information including price, inventory and certifications: [2x Frequency Multiplier Module, 32 GHz to 46 GHz Output Frequency, +8 dBm Output Power, Field Replaceable 2.92mm PE88X2002](http://www.pasternack.com/2x-frequency-multiplier-module-46-ghz-8-dbm-2.92mm-pe88x2002-p.aspx)

URL: <http://www.pasternack.com/2x-frequency-multiplier-module-46-ghz-8-dbm-2.92mm-pe88x2002-p.aspx>

The information contained in this document is accurate to the best of our knowledge and representative of the part described herein. It may be necessary to make modifications to the part and/or the documentation of the part, in order to implement improvements. Pasternack reserves the right to make such changes as required. Unless otherwise stated, all specifications are nominal. Pasternack does not make any representation or warranty regarding the suitability of the part described herein for any particular purpose, and Pasternack does not assume any liability arising out of the use of any part or documentation.

PE88X2002 CAD Drawing

2x Frequency Multiplier Module, 32 GHz to 46 GHz Output Frequency,
+8 dBm Output Power, Field Replaceable 2.92mm

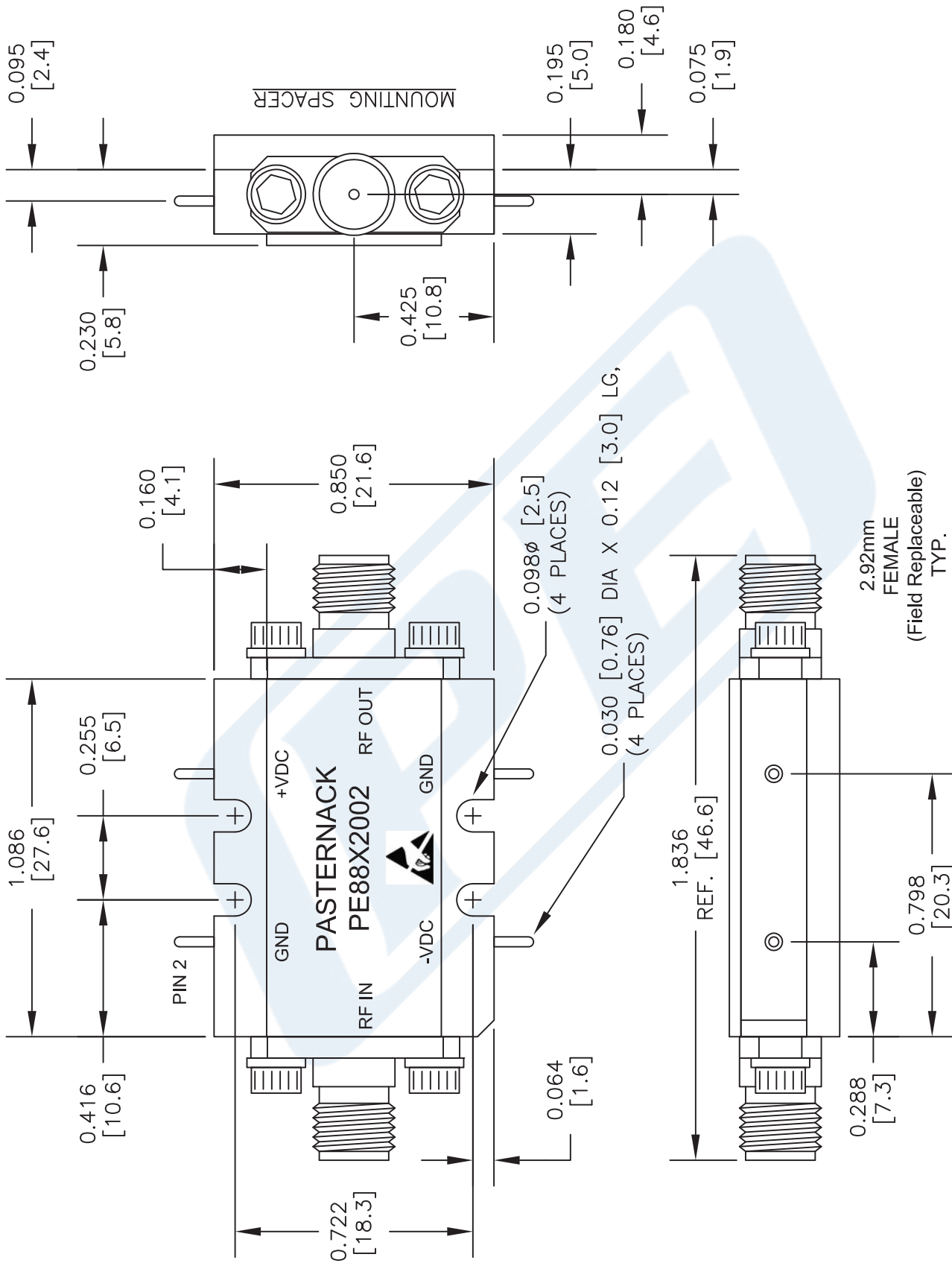

DWG TITLE

PE88X2002

NOTES:
1. UNLESS OTHERWISE SPECIFIED ALL DIMENSIONS ARE NOMINAL.
2. ALL SPECIFICATIONS ARE SUBJECT TO CHANGE WITHOUT NOTICE AT ANY TIME.
3. DIMENSIONS ARE IN INCHES [mm].

PE PASTERNAK
THE ENGINEER'S RF SOURCE
Pasternack Enterprises, Inc.
P.O. Box 16759 | Irvine | CA | 92623
Phone: (949) 261-1920 | Fax: (949) 261-7451
Website: www.pasternack.com | E-Mail: sales@pasternack.com

FSCM NO. 53919

CAD FILE 042216

SCALE N/A

SIZE A

2233